

COMPETENCE 318 V

AEG

Free-Standing Slot-in Electric Cooker

Instruction Book

AUS
ERFAHRUNG
GUT

Congratulations!

You are now the owner of a high quality, efficient and exciting cooking appliance.

From now on cooking should not only be made easier, but we believe you will find the new cooker a joy to use. The cooker will provide you with very good cooking results, is easy to use and maintain, if you take a little time to study the information contained in the instruction booklet, as well as in the lead-in pages of the accompanying recipe book. With just a little care the appliance will retain its superb appearance for many years to come.

You must read these instructions prior to using the appliance and retain them for future reference.



Contents

Safety instructions	
For the installer	4-6
For the user	7
Appliance description	
Features	8
First use	
Operating the controls	9
Switching on the electronic timer	9
Precleaning the ovens	10
Operating the electronic timer for both ovens	10-13
Hob	
Features	14
Vapour Vent	15
General	16
Operating the plates	17
How to use the ovens	
General	18
How to use the cooking functions for the ovens	18/19
Switching on and off	20
Baking	21/22
Roasting and stewing	23/24
Grilling	25/26
Specialised applications of the hot air oven	
- Menu cooking	27
- Defrosting	28
- Bottling	29
Cleaning and care	
Hob	30
Ovens	31-35
Optional extras	36/37
What to do if ...	38
Service	39

Safety Instructions

For the electrical installer.

To comply with safety regulations manufacturers have to draw your attention to the following:

- According to the technical connection conditions of the electricity board serving your area, the appliance may only be connected to the mains supply by an approved electrical installer.
- In the fixed connection, a device allowing the appliance to be isolated on all poles from the mains supply with a contact opening width of at least 3 mm must be provided. Suitable isolating devices are line protection switches, fuses (to be removed from the holder), FI switches and contactors.
- Please note that in the case of built-in furniture units the plastic coating or the veneer must be applied with a heat resistant adhesive (100 °C). If the plastic coating and the adhesive are not heat resistant, it is possible for the coating to deform or become detached, particularly along the edges of the built-in furniture units.
- In respect of fire protection, the appliance conforms to type Y (IEC 335-2-6). Only appliances of this type may be installed on one side of adjacent upright kitchen housings or walls.

The distance between a hob and fume extractor hood must be of the extent indicated in the installation instructions of the fume extractor hood.

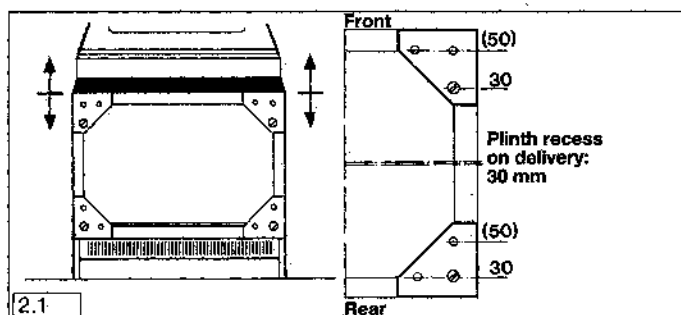

- The height can be adjusted up from 90 cm to 91 cm or 92 cm or down from 90 cm to 85 cm to line up with your kitchen furniture.

Remove the fixing screws in the plinth, adjust plinth to the height required and refit screws.

To compensate for uneven floor conditions, you may like to consider placing a foot (available from AEG Spare Parts Department) next to the rear castor.

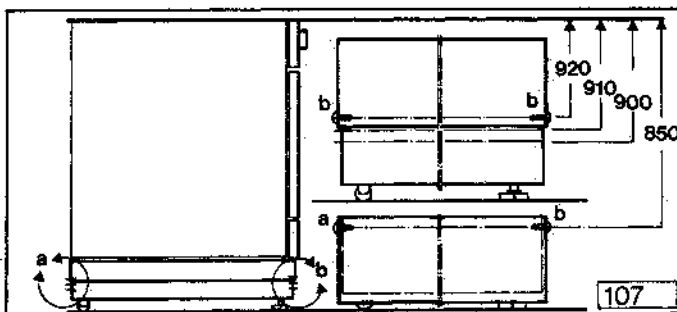

Electrical connection

Local and national electrical regulations must be observed.

All instructions given by the Electricity Board must be followed carefully when connecting the oven to the mains supply.

This is a job for a qualified and approved electrician. The appliance is rated for 240 volts single phase and must be permanently connected.

The cooker must be installed in such a way that it can be easily disconnected from the mains supply before servicing, e.g., by an adjacent cooker control unit.

Sufficient cable should be left to enable the appliance to be removed from the housing unit whilst still connected to the mains supply.

WARNING - THIS APPLIANCE MUST BE EARTHED!

Voltage and current

Please ensure that the voltage and current indicated on the rating plate agrees with the voltage of your electricity supply. 220-240 volts i.e., 220-240 V a.c.

1. Open the cover of the terminal box sideways as illustrated in fig. G.

**For the
electrical
installer**

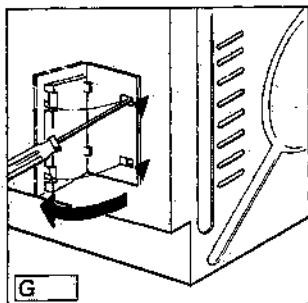

2. Pass cable through the grommet in the lower back panel and the cable clamp.
3. Connect the wires to the terminals in accordance with the diagram. Ensure that links are correctly positioned between terminals (5 or 6 way terminal block). The length of the earth conductor must be adequate to ensure that in case of the cable clamp breaking the earth wire is subject to mechanic strain only after the live wires.
4. Tighten the cable clamp screw.
5. Close the cover of the terminal box.
6. When pushing the cooker into its permanent position make sure that the mains cable is neither kinked nor trapped under the appliance.

After installation there must be no access to live parts.

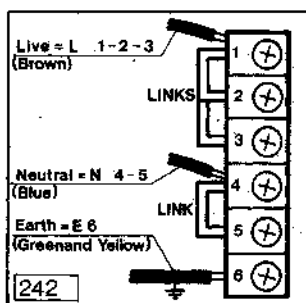

- **When you use the appliance to prepare your food, the oven doors and cooking plates become hot. Therefore keep small children well away from the appliance. This especially applies when you are grilling or pyrolytically cleaning the oven (where applicable).**
- Overheated fat and cooking oil may ignite. Prepare foods requiring fat or oil (chips) only under constant supervision.
- Do not use the appliance to heat your room.
- Take care when using small electrical appliances near the cooker. Connection leads should not come in contact with hot hobs/cooking zones or get trapped in the hot oven door.
- Do not use the ceramic hob as a table top.
- The ceramic hob is very durable but under certain circumstances it can break, e. g., heavy or pointed objects dropping onto the surface.
In case of breakage or cracks, do not use the hob. Turn all the controls for the hob to 0 and isolate the appliance from the electrical supply.
- Do not line the oven base with aluminium foil or place any other cooking utensil on the base, as this will trap heat resulting in damage to the enamel interior. This invalidates the warranty.
- The cooling fan, where featured in ovens and cookers, can continue to run although all oven switches are turned off. It will switch itself off automatically. The cooling fan can also come on automatically although the oven is switched off if the residual heat in the oven is too high. The fan switches itself off automatically.
- The vitreous enamel in your oven is very durable. However vitreous enamel is adversely affected by fruit acids (rhubarb, lemon, etc.) and tea which will discolour and dull the enamel. The performance of the oven is not affected. To prevent spillage of the above coming in contact with the enamel, place the cooking container on a baking sheet.
- **Do not place the grill/meat pan on the cooking plate to make gravy.** The direct heat will weaken the pan base resulting in warping and twisting of the pan when next used as a meat or grill pan.
- The appliance complies with radio interference suppression specifications EN 55014 (previously EEC Directive 87/308) and as appropriate with EN 60555 relating to the Retroactive Effect of the Mains Supply.

Appliance description

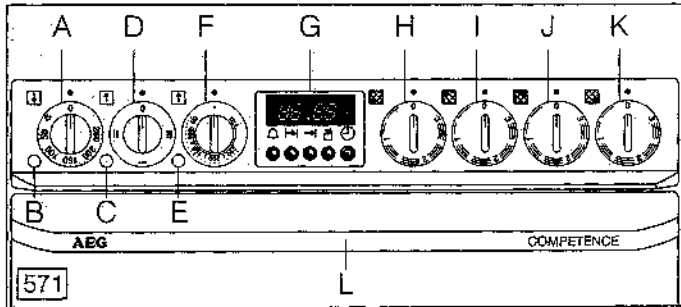

Features

- A** Temperature control for **main** oven
- B** Thermostat control light (red) is on when **main** oven is heating
- C** Pilot light (yellow) is on when the appliance is switched on
- D** Cooking method selector for **secondary** oven
- E** Thermostat control light (red) is on when **secondary** oven is heating
- F** Temperature control for **secondary** oven
- G** Electronic clock with minute minder, and auto-timer for **both** ovens
- H** Control knob for 210 mm diameter plate, front left
- I** Control knob for 145 mm diameter plate, rear left
- J** Control knob for 180 mm diameter plate, rear right
- K** Control knob for 145 mm diameter plate, front right
- L** Handles to open the **oven doors**

The vapours from the two ovens are vented from the rear of the hob up to a cooker hood above (where fitted).

First use

The control knobs (D, H, I, J and K) can be turned clockwise or anti-clockwise to any position. Further information to this can be found in the "hob" and "oven" sections.





However, the oven temperature control knobs (A) and (F) must be turned clockwise to set and anti-clockwise to turn off.

As soon as the appliance is connected to the mains supply (and also after a power cut), the indicator in the electronic timer flashes

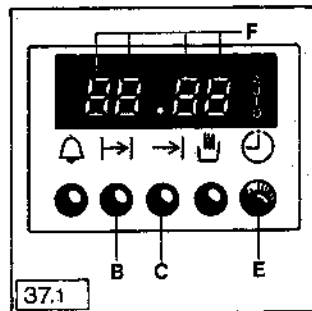

When you have set the correct time of day the appliance is ready to operate.



- Press knob E  to release. (This does not apply to appliances with an enamelled control panel.)
- When finished with knob E  press to retract. (This does not apply to appliances with an enamelled control panel).
- Press buttons B  and C  at the same time, hold them in position, and set the actual time of day by turning the knob E .

The time of day appears for you in display F. Now the oven is ready to operate.

Operating the control knobs

Switching on the electronic timer

Setting the time of day

You should also be aware of the following:

Pre-cleaning the ovens

Before using the ovens for the first time, clean all accessories (shelf supports, wire shelves and pans) with warm water and washing-up liquid. Then switch both the ovens either to the conventional or the hot air cooking method (as appropriate) and select the highest temperature and leave both ovens on for at least one hour with both oven doors closed.



During this period there is an unavoidable odour which is not harmful to your health. **We recommend that the room is well ventilated for your convenience.**

When the ovens have cooled down, clean any parts not lined with catalytic self-cleaning panels with water and washing-up liquid.

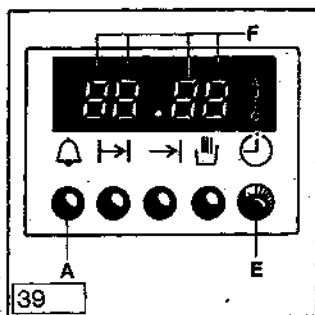
Operating the electronic timer



Setting the minute minder





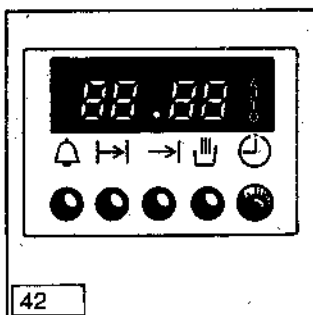

- Press button A , hold it in position and set the required time with knob E . The duration appears in display F.
- The time of day reappears in display F after release of button A.
- To check the cooking time, press button A . The remaining cooking time now appears in display F.

You should also be aware of the following:

When the selected time has elapsed you will hear an audible signal which will switch off automatically after approximately 2 minutes. To switch this off manually press button A .

The electronic timer is designed to switch the ovens on and off automatically.







-  Setting the **minute minder**
(up to 23 hours 59 minutes)
-  **Manual or automatic operation** of the oven
-  Setting the **cooking duration** of the oven
(up to 23 hours 59 minutes)
-  Setting the **end** of the cooking duration
(up to 23 hours 59 minutes in advance)
-  **Rotary control for time selections**
-  **AUTO** is illuminated during time controlled cooking

The symbols have the following meanings:

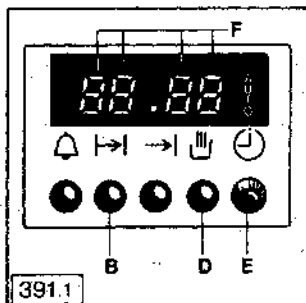

How to programme the oven to switch off automatically

You should be aware of the following:





- Select the cooking method and temperature as required.
- Press button B , hold it depressed, and enter the required **duration** with knob E . The cooking duration appears in display F and symbol  is illuminated. When button B is released the time of day appears in display F.
- **Symbol  shows throughout time controlled cooking.**



The oven immediately switches on and automatically off after the elapsed duration.

At the end, an audible signal sounds for about two minutes and symbol  flashes. By pressing button D  the oven is switched from automatic to manual operation. Symbol  goes out.





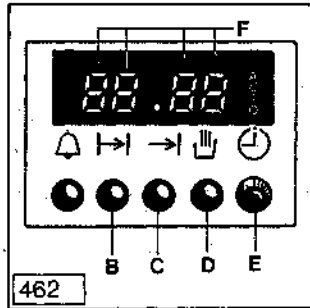

After time controlled cooking, set the cooking method selector and temperature control to the off position.

The oven is ready to operate manually again.

You can check on the remaining **cooking duration** and the **cooking end** at any time during time controlled cooking by pressing either button B  or C .



If you want to cancel automatic operation, press button B  and turn knob E  until 0.00 appears in the display F. Then set the cooking method selector to the **0** and oven temperature control to the off position.







- Set the cooking method selector and temperature control as required.
- Press button B , hold it depressed and enter the required **duration** with knob E , and then, by pressing button C , set the cooking end time.
- When buttons B  and C  are released, the time of day reappears in display F. **Symbol  is illuminated.**

The oven switches on automatically at the correct time, having deducted the cooking duration from the cooking end. It then switches off automatically at the cooking end.

At the end, an audible signal sounds for around two minutes. You can prematurely cancel it by pressing button B .

By pressing **button D ** the oven is switched from automatic to **manual** operation. **Symbol  goes out.**

You can check the remaining **cooking duration** and the **cooking end** at any time during time controlled cooking by pressing either button B  or C .

If you want to cancel automatic operation, press button B  and turn knob E  until 0.00 appears in the display F. Then set the cooking method selector to the 0 and oven temperature control to the off position.

Automatic switch-on and -off of the oven

You should also be aware of the following:

The oven is ready to operate manually again

The Hob

Ceramic cooking zones

Your hob features 4 ceramic cooking zones with stepless control for maximum controllability.

The control knobs on the panel feature indicators to show which control knob belongs to which cooking zone.

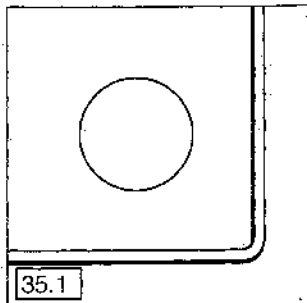

■ Residual heat indicators

There is a residual heat indicator for each of the cooking plates on the ceramic hob (2 lights on the left and 2 on the right). When the indicator is on it means the plate is still hot. After the plate has cooled down the indicator lamp goes out.

The vapours created in the oven(s) are vented through the back of the hob. Further details can be found in the section "Vapour Vent".

Vapour vent

The vapours created in the oven are vented through the back of the hob.

Please press the push-button only when the cooking plates are not in operation to prevent the risk of burning yourself. Should you operate the push-button when the cooking plates are in use, we recommend you to use a long-handled cooking spoon to open or close the vent.

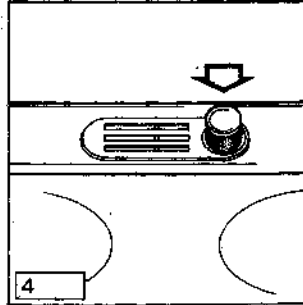

This enables you to control the moisture in the oven during baking or roasting.

Closed: **Push-button released,** red edge visible
Open: **Push-button pressed**

You may close the vapour vent during preheating and during the first third of the cooking time when baking bread or bread rolls to obtain better rising and browning.

During roasting, you may also keep the vapour vent closed, unless you want to achieve a crispy brown finish, e. g. for poultry, pork, roast potatoes etc.

The separate tables on baking and roasting contain more detailed instructions.

General – the correct pans

Good pans for better results

- For best results use good quality pans with smooth flat bases.
- The pan base should be thick and flat. Pans with uneven, distorted or rough bases (e. g., cast iron) should not be used as they extend the cooking times and may cause damage to the cooking plates.
- Cooking plates and pan base should be of the same or similar diameter. The pan should be placed centrally on the cooking plate.
- Cooking plates and pan base must be clean to prevent damage to the hob and waste of energy.
- Shiny and copper based pans are unsuitable for use on halogen cooking plates. These pans may also damage the decor on normal ceramic hobs so do avoid using such pans on a ceramic hob. Copper base saucepans are also unsuitable, they will damage the hob surface.
- Follow also the recommendations of the saucepan manufacturer.

Make use of the residual heat – switch the plates off 5–10 minutes before the end of the cooking time.

You are wasting energy and prolonging the cooking times if:

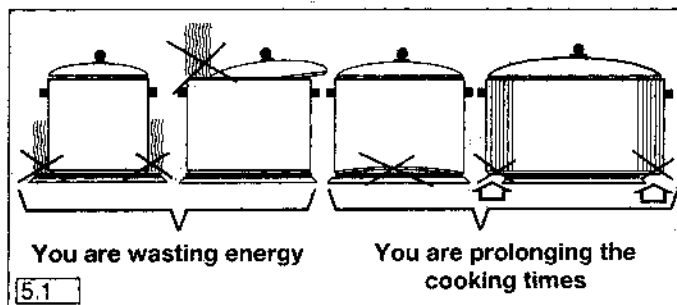

Pan too small

Lid not closed

Uneven pan base

Pan too large (ceramic)

(Ceramic and solid plates)

After you have switched on one of the ceramic plates you will hear a faint hum caused by the radiant heating elements.

Do not place aluminium foil or plastic containers on the hot ceramic hob.

Do not allow sugar or foodstuffs containing sugar to come in contact with the hot ceramic hob – it will damage the hob.

Protect the cooking areas from damp to prevent them from deteriorating; dry pan base before use; dry cooking areas well after cleaning.

Keep the cooking plates clean – soiled plates work less efficiently and damage may occur to the hob.

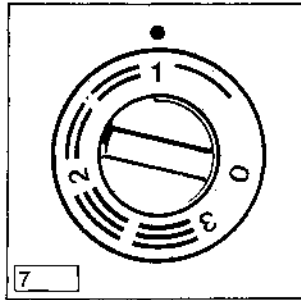

The cooking plate is infinitely variable.
The chart below shows some basic settings and their uses.

- 0** Off. Use of residual heat
| Holding warm, simmering of small quantities
- 1** Simmering
|| Simmering of larger quantities, slow frying
- 2** Frying, making roux
||| Frying
- 3** Fast frying/boiling, deep fat frying

To start cooking set control to 3 to heat pan and contents, continue cooking on a lower setting as required.

Important information when using the cooking plates

Using the stepless cooking plate

Ovens

General

Before using for the first time, refer to the section describing pre-cleaning of the ovens.

The **secondary oven** is a conventional one with top and bottom heat and grill.

When the oven is in use the cooling fan is on.

The **main oven** is a hot air oven. For further details consult the relevant sections in this booklet.

Cooking methods for secondary oven

The different cooking options



- Conventional electric cooking



This method of cooking uniformly radiates heat from above and below. You should however make sure that you only cook on one level to ensure a uniform distribution of heat.

- Dual-circuit grill



To grill large quantities of food use the large grill area . For smaller quantities, e. g., 4 slices of toast, use the smaller grill area .

Hot air cooking in the main oven

Hot air cooking



A fan ensures that hot air is continuously circulated around the oven allowing you to cook, bake and roast at several levels simultaneously. This cooking method also uses lower temperatures. This system saves you time and is highly energy efficient.

Shelf levels – main and secondary ovens

The ovens feature shelf supports which are removable for cleaning.

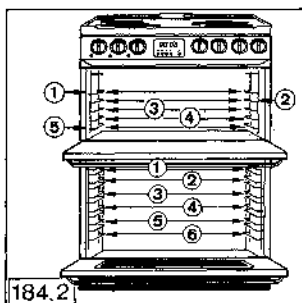

The cooking tables supplied recommend the shelf positions on which the **main** oven will produce best results.

The secondary oven operates on top and bottom heat and you would use the bottom shelf position or the next one up for most of your cooking.



Fat filter

The fat filter supplied protects the fan against soiling. **It must always be in place when:**

- Meat is cooked in uncovered containers using the hot air mode  (do not insert when baking!);
- During Rotitherm roasting/grilling  (on multi-function ovens only) or traditional grilling.

How to insert the fat filter:

Hold the fat filter by the handle and insert the two tabs (see illustrations) into the slots in the back panel of the oven thereby covering the fan opening.

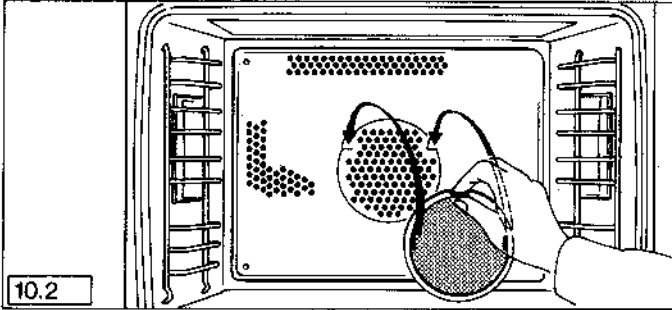

The fat filter must cover the opening completely.

Cleaning the fat filter:

To clean the oven all oven controls must be set to the off position. The fat filter should be cleaned after every use. To remove the fat filter hold it by the handle and pull upwards.

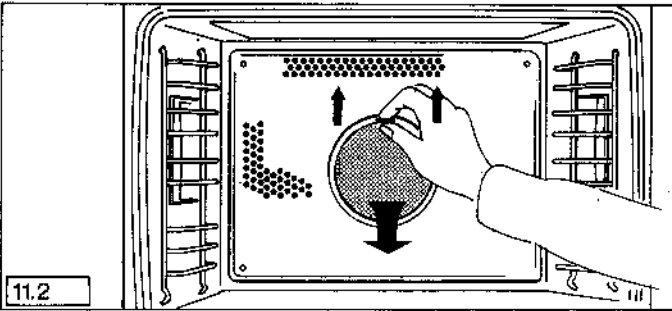

How to clean the filter, see "Cleaning the fat filter" in this booklet. The fat filter must only be clipped into the oven when it is **totally dry**.

Switching on and off

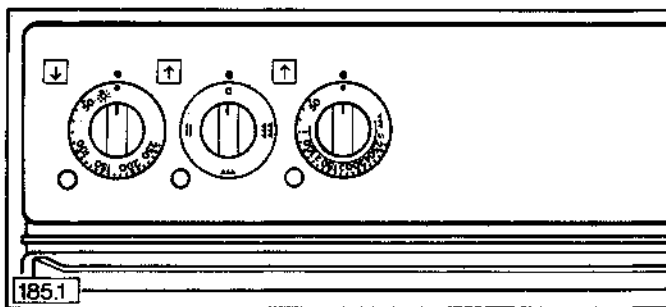

Oven interior light

The main oven is illuminated when you turn the oven temperature control to the lamp symbol .

Secondary oven

Decide whether you want to use the conventional oven or the grill. Select the relevant symbol on the cooking method selector and the temperature required.

Main oven

Turn the temperature control clockwise to the required temperature.

Both ovens

The red thermostat lights are on for as long as the ovens are pre-heating. The thermostat lights cycle on and off during operation, indicating heating periods.

When pre-heating the oven (see information in the relevant cooking charts) position food in the oven after the red thermostat light has gone out for the first time. To utilise the residual heat in the oven switch the oven off 5–10 minutes before the end of the cooking time by returning the oven controls, anti-clockwise, to the off positions.

■ **Bakeware**

Cakes are baked either in cake tins or alternatively on baking-sheets, full width baking sheets are available from AEG Spare Parts as an optional extra.

How bakeware affects browning:

1. Bakeware, which is dark in colour, has a non-stick coating or is made from aluminium is the best as heat is absorbed and then transferred to the cake resulting in shorter cooking times, lower energy consumption and better browning.
2. Bakeware which is light in colour or is made of tin reflect the heat resulting in longer cooking times and poorer browning. It is advisable not to use such bakeware when using conventional top and bottom heat.

■ **Baking on one level provides the best results in the conventional mode.**

The shallower the cake, the higher you should place it in the oven.

■ **Baking times and temperatures**

In many cases, it is not necessary to preheat. The recommended temperatures and times given in the enclosed chart are guidelines only. To suit personal taste it may be necessary to make small adjustments.

■ **Recommendations**

The hot air mode is recommended for all types of baking. However, you may prefer cooked cheesecakes, sponges, bread and rich fruit cakes cooked by the conventional method.

When you use the hot air cooking system you can cook on several levels simultaneously. This saves time, is convenient and energy efficient. You can also cook different cakes at the same time for instance a Victoria Sandwich and a Bakewell Tart or a Madeira Cake with a Dundee Cake. Simply make sure that the cooking temperatures are roughly the same and that sufficient space is left between the shelves to allow the air to circulate freely.

If baking cakes with a high moisture content such as several apple pies, it may be advisable to use only 2 shelves at the same time to prevent too much steam forming in the oven.

Baking With conven- tional top/ bottom heat



With hot air



■ Baking times and temperatures

When baking with hot air it is often unnecessary to pre-heat the oven. For exceptions see enclosed baking charts.

If you use the oven for batch baking, choose cakes which require similar temperatures. Different cooking times can be overcome by either placing cakes into the oven later or by removing them earlier.

The baking chart is provided as a quick reference to keep near the oven.

When baking on more than one level the time given in the cooking charts has to be extended by 10–20 minutes.

■ Baking on one or more levels

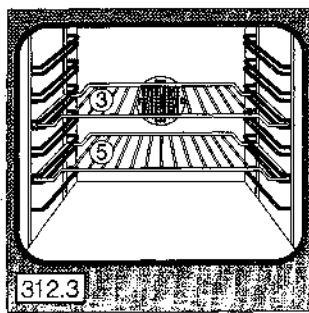
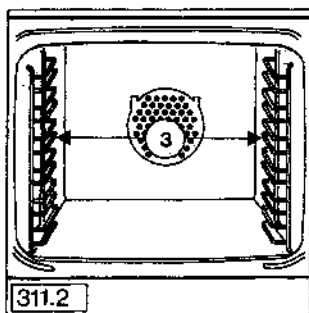

You can bake on several levels simultaneously. Place cake tins centrally on the wire shelves to ensure even cooking results. Full width baking sheets and additional wire shelves are available as optional extras – see section "Optional Extras" in this booklet.

Roasting and stewing

Main oven with hot air.

Secondary oven with conventional top and bottom heat.

Recommendations

Wipe and weigh the meat. If stuffing is used, weigh the stuffed joint to calculate the cooking time. Place the joint in a suitable roasting dish, season with salt and pepper and brush lean joints with melted fat.

When cooking pies, place dish on a baking sheet to avoid spillage on to the floor of the oven.

- The times and temperatures given in the roasting chart provide a guide when cooking meat. Some adjustments may be necessary depending on the type of meat to be cooked. Cooking times have been given for meat which is at room temperature.
- Prime cuts can be cooked at higher temperatures than those which require a longer cooking time to tenderise the meat. A thick joint will require longer to cook through than a thinner one.
- A boned rolled joint will require a longer cooking time than one with the bone left in as bone is a conductor of heat.
- A small joint will require longer cooking time per 450 g (1 lb) than a large one. Allow an extra 30 minutes cooking time for joints up to and including 1.5 kg (3 lb).
- If the joint is cooked in foil the temperature has to be increased by 10 °C. To brown the joint, remove foil for the last 15 minutes or so of the cooking time.
- If cooking from frozen, place joint in a covered container and extend the calculated cooking time by approximately one third. To brown and crisp meat remove cover for the last 30 minutes of the cooking period.

Cooking temperatures and times

Ovenware

Never use stainless steel ovenware in the oven, since it reflects the heat. Meat, poultry, and fish should be cooked in ovenproof dishes or in the meat pan for large quantities.

Choose a dish which is just a little larger than the joint itself. This will contain any fat in a smaller area and reduce splashing. If you wish to roast potatoes in the same dish around the joint rather than in a separate one you need to make allowances for this when selecting a suitable dish.

Never place cooking containers on the base of the oven, but on the wire shelf which you should insert on the 4th or 5th level from the top depending on the size of the food to be cooked.

When using the Rotitherm roasting/grilling method (where featured) place the joint on the wire shelf 3rd and 4th from the top (depending on size of roast) and slot the drip-pan into the 5th or 6th from the top to catch the juices. If you want to roast potatoes in the dripping, allow approximately 1-1¼ hours cooking time. Turn the roast over halfway through cooking to ensure an all round crisp and brown joint.

General

Secondary oven

The secondary oven is useful for cooking **small** quantities of food, e. g., one small cake or a small roast (max. 2 kg). Do not overload the secondary oven as too much food may result in excessive amounts of steam developing.

When using the secondary oven place the cooking container on a wire shelf having removed all other oven equipment first.

Warning!

The handle must be removed whilst grilling. Failing to do so will result in overheating of the handle. This may cause damage leading to breakage of the handle.

**Inserting/
removing
grill handle**

Inserting the handle

Lock it into the grip at the front of the pan. See illustration.

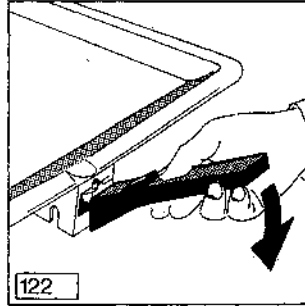

Make sure that the handle is firmly attached to the pan!

Removing the handle

Press the button on the handle. See illustration.

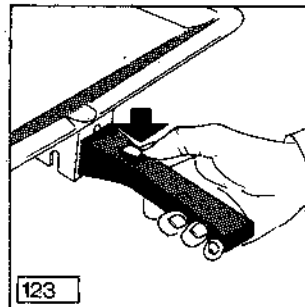

Traditional grilling





and



How to use the grill

Prime cuts of meat such as steaks and chops or fish weighing less than 1 kg can either be fried or grilled. Salt large pieces shortly before grilling and small ones just after grilling.

Turn meat/fish after half the grilling time so that both sides are uniformly browned. Turn thin pieces once; thicker pieces need turning more often.

On appliances with a dual circuit grill , you should set the grill to grill symbol  for small amounts and to symbol  for larger amounts.

Select the highest setting on the variable temperature selector to seal the food and then turn down to a lower temperature. Position the wire shelf with the projection facing upwards or downwards in a shelf position of your choice depending on the thickness of the food you wish to grill.

Place the grill pan on the wire shelf and remove the grill pan handle.

Where the appliance features a vapour vent, this must be open during grilling.

Main oven: the oven door is closed during grilling (if oven features a grill element)

Secondary oven: the oven door is left OPEN during grilling.

There is no need to pre-heat the grill unless you prefer to do so.

Grill pan and wire shelf can be cleaned more easily if soaked in the sink with water and washing-up liquid after grilling.

Menu cooking in the main oven

- The hot air oven is extremely versatile since you can cook a complete meal in it. You can cook different foods at the same time, such as fish and cakes, without any transfer of smell or taste from one to the other.
- When menu cooking try to choose foods which require similar cooking temperatures.
- When cooking meat in uncovered containers the **fat filter** must be inserted.

When cooking pies or cakes at the same time as a roast you can choose pies or cakes which normally cook at temperatures 20 °C lower than the roast. Temperature differences of 10 °C lower than the roast can be compensated by longer or shorter cooking times.

Shelf positions are chosen according to the food being cooked and in connection with the cooking guidelines in the recipe book supplied.

Menu suggestion:

Meat Loaf
Potato Bake
Buttered Carrots
Fruity Rice Pudding

Ovenware:

Oblong ovenproof dishes

Shelf positions:

Meat Loaf & Potato Bake
Side by side 3rd from top
Carrots and Fruity Rice Pudding
Side by side 5th from top

Cooking method:

Hot Air

Temperature:

170–180 °C

Time:

Approx. 60–75 minutes

Vapour vent: (where featured)

Open unless you wish to retain moisture in the oven to prevent food from drying out, such as pheasants, etc.

Defrosting by Hot Air



**In the main
oven**

- Food in flat aluminium containers defrosts especially well since aluminium is a good heat conductor. For freezing and subsequent defrosting of meat and vegetable dishes, flat aluminium containers should therefore be used. For defrosting uncooked frozen meat and fruit, closed ovenproof dishes are especially well suited.
- Position the containers on the wire shelf or in the meat pan 4th from the top.

Food	Temp. °C	Time - Hours/minutes	
Ready-made meals (1-4 portions)	200	0.40-0.50	thawing and heating ready to serve
Small cakes without cream fillings or top- pings (in foil)	200	0.15-0.20	ready to serve
Large cakes without cream fillings or top- pings (in foil)	200	0.30-0.45	ready to serve
Un sliced bread in foil (approx. 450 g/1 lb)	200	0.15 + 0.30 at room temp.	ready to serve
Bread rolls	200	0.15 + 0.30 at room temp.	ready to serve
Fruit, e. g. 300 g strawberries, raspber- ries (in covered con- tainer)	200	0.15 + 0.15 at room temp.	ready to serve
Ready to cook foods (pizza, pies)	200	0.45-1.00	ready to serve
Uncooked joints (e. g. 1.5 kg)	180-200	2.00-3.00 depending on type of meat	thawed and cooked
Chicken approx. 1 kg (cover with greaseproof paper)	50	1.00-1.15	thawed, remove giblets and roast

Bottling in the main oven

- For bottling, use only jars with rubber seals and glass lids. Never use jars with screw fittings or bayonet catches or metal tins. And make sure you use fresh foodstuffs!
The oven holds 6 bottling jars of 1–1.5 litres capacity. Place 1 cup of hot water in the drip-pan so that the necessary humidity is retained in the oven.
- Position the jars in the enamelled pan on the 4th level from the top. The jars should not touch, must wherever possible be filled to the same level with the same contents and must be securely clamped.
- To **switch on**, turn the oven temperature control to 160 °C.
- **Keep an eye** on the food being bottled.
As soon as the liquid in the first jars (when bottling **fruit** or **gherkins**) **begins** to bubble (after around 40–45 minutes for 1 litre jars) switch off the oven, but allow the jars to stand a further 30 minutes or so – around 15 minutes for soft fruit, e. g. strawberries – in the closed oven.
When bottling **vegetables** or **meat**, set back the oven temperature control to 150 °C as soon as the liquid in the first jars **begins** to bubble and allow the contents to **cook** for a further 60–90 minutes. Then switch off the oven and allow the jars to stand a further 30 minutes in the closed oven.

Cleaning and care

Ceramic hob – general

Although ceramic hobs are easy to clean they require regular care and cleaning to maintain them in good condition. Let the hob cool down before cleaning.

1. Never use abrasive cleaners or scouring powders or scouring pads.
2. Clean the hob after every use while the soilage is still minimal. Use a soft damp cloth and a little washing up liquid. Rub the hob dry using a soft clean cloth. Make sure that no residual cleaning material is left on the hob.
3. Once a week clean the hob thoroughly with "Stahl-fix" or "WK-Top" (available from AEG Spare Parts Department) using a soft clean cloth. Clean the hob with clean water and polish dry with a clean soft cloth. Make sure that no cleaning material is left on the hob to prevent damage to the hob.

Boiled over food

Soften such soilage with a damp cloth then remove deposits carefully using a glass scraper in a patent holder. Then clean the hob as described under 3.

Sugar and foodstuffs containing sugar – Plastic materials

Do not allow any of the above to come in contact with the hob. If they do, remove from the hob immediately while still hot using a glass scraper in a patent holder. Then clean hob after it has cooled down as described under 3. Melted sugar or plastic may damage the hob permanently. Damage by the above may be reduced by regular treatment with "Collo-profi" or "Cera-fix" (cleaner/conditioner) available from AEG Spare Parts Department.

Stains

Mineral deposits present in hard water and food may cause discoloration in the form of grey, blue or mother of pearl stains which appear to be in the surface. Clean such discolorations while the cooking area is still warm (not hot) as described under 3.

Make sure that the cooking areas and the pan bases are clean before use. Grit for instance from vegetable peelings will scratch and damage the hob surface.

Recommended Cleaners

"Stahl-fix" for normal or heavy soilage, "Cera-fix" or "Collo-profi" for light soilage and conditioning. These are available from AEG Spare Parts Department: "Stahl-fix" E No. 022 300 702.

"Collo-profi" E No. 661 908 524, "Collo-profi" set consisting of "Collo-profi" glass scraper and polishing cloth E No. 661 908 626, and "Cera-fix" E No. 022 300 703.

A razor blade in a patent holder held at an angle of 30° can be used to remove stubborn soilage. This is also available from Spare Parts Department – E No. 298 001 273.

These instructions refer to a large range of AEG double and single ovens.

- All secondary ovens have a catalytic roof panel as standard.
Some models have a complete catalytic set provided as standard. For those models which do not have it as standard it is available as an optional extra.
- The main oven has catalytic roof (except Vitratherm ceramic roof models), sides and back panels, either as standard or they are available as optional extras from your AEG retailer depending on the model you selected to buy (except ovens which include microwave). If your main oven has a pyrolytic self-cleaning system, then also consult the relevant pages for cleaning the oven.

Before cleaning the ovens

Allow the ovens to cool down if they have been used before cleaning. Switch off the ovens before cleaning.

Cleaning

Ovens which are cleaned after every use need very little attention. If left and used again fat splashes will bake on and are then difficult to remove.

Clean **glass surfaces, trims and controls** with a soft cloth and lukewarm water. Polish dry with a soft cloth.

The ceramic glass oven roof (Vitratherm – where featured) can be cleaned with an oven spray or with "Ovenpad" or "Kleenoff".

Vitreous enamel interior surfaces can be cleaned with:

- a damp cloth and mild detergent
- cream cleaners such as "Jif" and a cloth.
- oven cleaners such as "Ovenpad" or "Kleenoff". Do follow the manufacturer's instruction on the cleaning materials you use carefully.

Take care that oven cleaners do not come in contact with the fan or any other part of the oven other than the vitreous enamel.

Do not use scouring pads or abrasive powder which may scratch the surface of any part of the appliance.

Do not use any detergents, abrasives or oven cleaners on catalytic liners.

It should not normally be necessary to clean the catalytic roof in water. If you feel you would like to do so, take out the roof and wash in warm, soapy water, followed by rinsing in clear water.

Ovens

Secondary Oven

Main Oven

Catalytic liners

Secondary oven

Main oven

If your oven has a catalytic roof, sides and back panel either as standard equipment or if you have bought these parts separately and fitted them, then the following information will be of interest to you.

The liners help to keep the oven cleaner as they clean themselves to a great extent during roasting and baking at temperatures above 200 °C. As cleaning may be improved by exposure to a higher temperature it may be necessary to run the oven at 250 °C for 1 or 2 hours per week. Before carrying out such a heat cycle, remove all oven equipment and make sure that you have cleaned the unlined surfaces to prevent any soil from baking on. For isolated stubborn stains use a soft brush and very hot soapy water. Never use abrasive cleaners or scouring powders.

Cleaning the lamp cover(s) or replacing the oven lamp(s) in the main oven

Warning! Isolate the oven from supply before replacing the oven lamp(s).

To clean the glass cover(s) or change **the oven lamp(s)** the **glass cover(s) should only be unclipped by hand. Do not use tools of any kind.**

After cleaning the lamp cover(s) or changing the light bulb(s) refit the lamp cover(s).

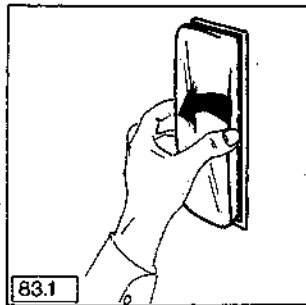

Oven lighting

You can **illuminate** the oven for cleaning. To do this, turn the oven control knob or the cooking method selector to the lamp position .

■ Thorough cleaning

For thorough cleaning, you can remove various parts:

- Removing the oven door
 - Fully open the oven door.
 - 1. Pull the door catch on both door hinges towards you (see illustration).
 - 2. Lift the door up and pull forward away from the oven (**grip the sides – do not pull on the door handle!**).

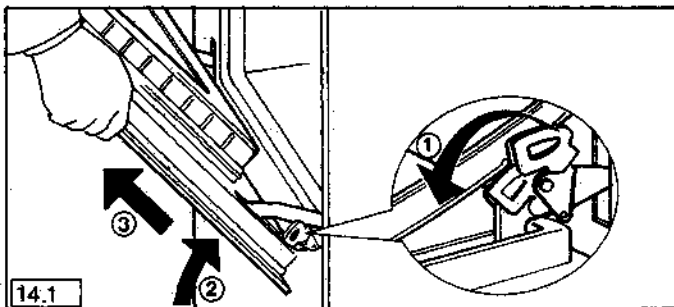

- Replacing the oven door
 - 1. Insert both brackets into the oven frame.
 - 2. Fully open the door and return door catches to their working positions (see illustration).

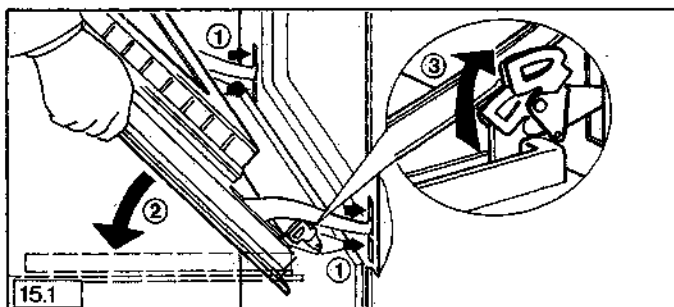

Removing the oven door (main and/or secondary ovens)

Removing the shelf supports

■ Shelf supports

To clean the sides of the oven, the shelf supports (see illustration) can be removed.

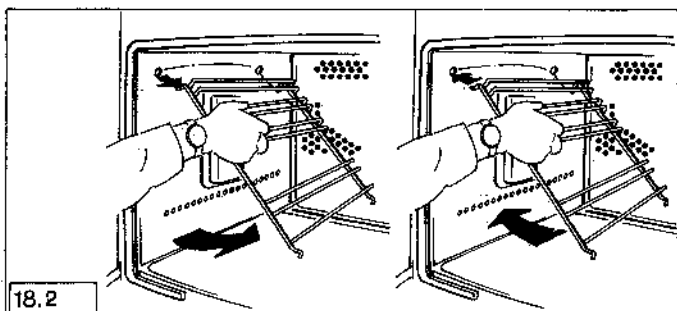

Pull the shelf support at the bottom, towards the centre of the oven and unhook from the top. Replace in reverse order.

Cleaning the catalytic roof in the second oven

The catalytic roof of your oven may require cleaning from time to time.

To remove the roof panel proceed as follows:

Loosen the **two holding screws**

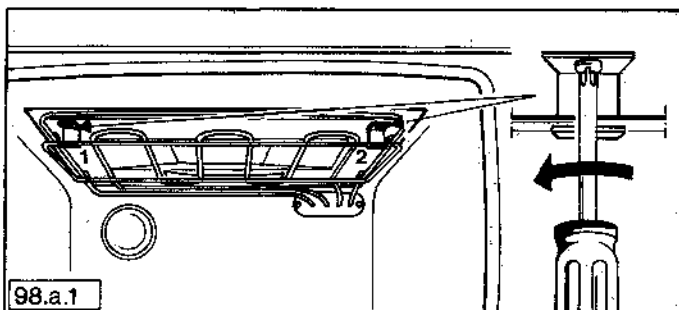

Remove the catalytic roof for cleaning

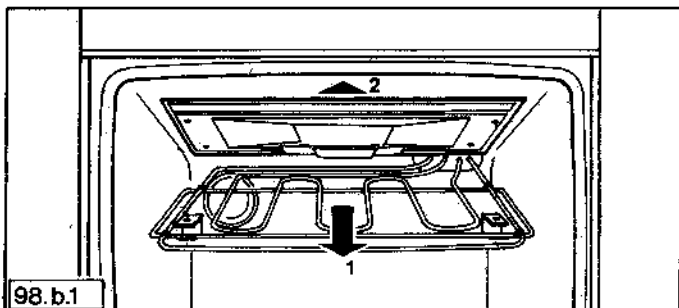

After cleaning re-insert roof panel and re-fasten screws

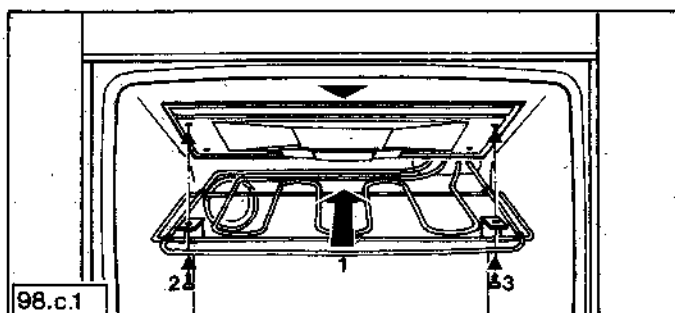

The fat filter should be cleaned after every use. To remove filter, hold it by the handle and lift upwards. Place the fat filter in a saucepan, add approximately 1 tbsp. of automatic washing powder or 1 tsp. of dishwasher powder and cover filter with water. Bring to the boil and leave to soak for approx. 30 mins. or longer depending on the degree of soiling. Make sure the solution does not boil over as it could mark your hob. Rinse filter in clear water and dry. For light soilage wash in a 65 °C dishwasher programme.

Cleaning the fat filter

Optional extras

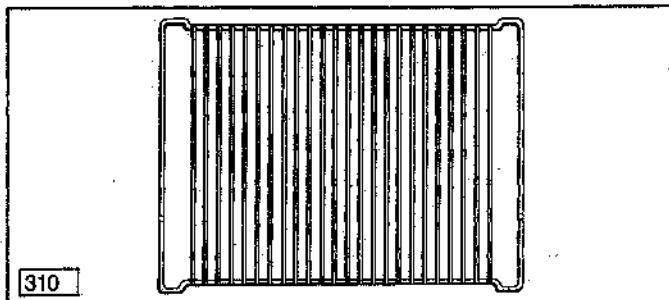

Additional wire shelf
ET No. 661 307 541

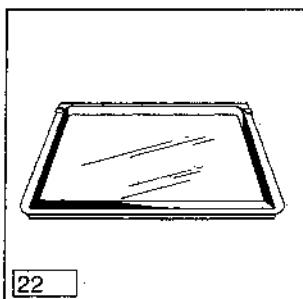

Baking sheet
E No. 611 898 620

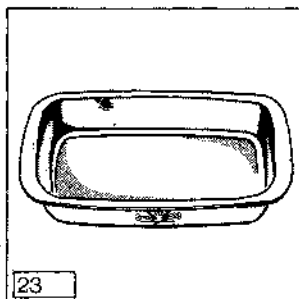

Ceramic oven dish
E No. 611 899 660

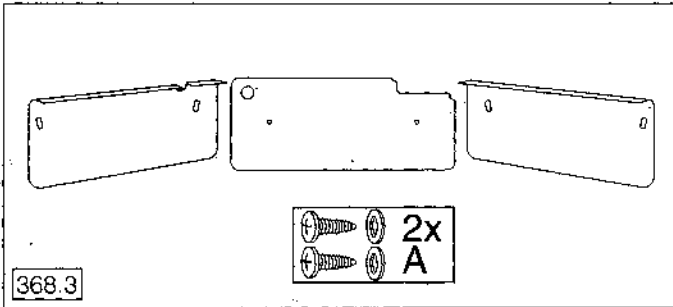

KTKBO (catalytic set for secondary oven without lamp)
E No.: 611 898 612

What to do if ... (something goes wrong?)

Faults you can rectify yourself

... the pilot lamps do not show?

... the oven does not heat?

1. You may well have not operated all relevant switches or
2. The fuse in the fuse box has blown.
3. **IMPORTANT** – Make sure that the oven door is closed completely.

... the fuses keep blowing?

Please call an approved and qualified electrician.

... the oven lamp fails?

See Cleaning and care on page 32.

Replacement lamps are not covered by warranty and are not free of charge.

... the oven cannot be switched on?

Check whether:

- ... **the clock display** is flashing! If yes reset the time of day.
- ... **the audible tone of the timer** is emitting a continuous tone. Then press the corresponding button to switch it off!
- ... **the timer display** does not show, but the pilot lamps of the appliance still show?
- ... **incorrect indications** appear in the display?
- ... **duration and end** cannot be entered!

The timer has been wrongly operated or there has been a short power cut. Isolate the oven from the power supply **wait 30 seconds** and then switch on the power. Reset the time of day on the electronic timer.

Please make sure that you are not able to rectify the fault yourself prior to calling a service engineer in connection with one of the aforementioned problems, as the cost involved will have to be passed on even during the warranty period.

Therefore, follow the instructions in this booklet and any additional information which may accompany this appliance carefully.

AEG electrical appliances comply with current safety regulations. Repairs to these appliances should only be carried out by qualified AEG engineers or AEG appointed service agents. Repairs carried out by unauthorised personnel could lead to considerable damage and could pose a considerable safety hazard to the user.

Service

Should you be unable to locate the cause of the problem in spite of the above check-list please contact your **AEG** service department quoting the **E** and **F** numbers which you will find on the rating plate (see illustration/arrow).

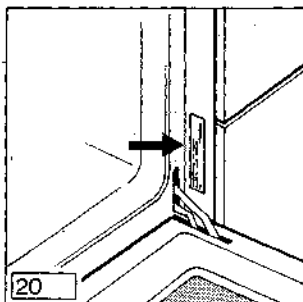

Please transfer these numbers to the space provided below for your convenience.

These numbers enable the service department to prepare as far as possible any spare parts required to rectify the fault on first call. This may save you money.

E-No.

F-No.

AEG Service Locations in the United Kingdom

AEG UK Limited Head Office

217 Bath Road
Slough, Berks. SL1 4AW
Tel.: 0753 872506
Telex: 847541
Telefax: 0753 512271

AEG Northern Service Centre

Unit 20, Haigh Park
Haigh Avenue
Stockport
Gl. Manchester SK4 1QR
Tel.: 061 487 2205
Telefax: 061 474 1191

AEG Scottish Service Centre

Block 11, Unit 1
Dundyvan Industrial Estate
Coatbridge
Lanarkshire ML5 4AQ
Tel.: 0236 440387
Telefax: 0236 440256

Service Appointments

Bristol (call diverted to Slough) 0272 252880
Norfolk (call diverted to Slough) 0603 765515

AEG

AUS
ERFAHRUNG
GUT

AEG Hausgeräte AG
Postfach 1036
D-90327 Nürnberg

© Copyright by AEG

H 260 275 540 - 06931./03 -